

## SIM100 KIT FOR HUSKY 100

FOR MAXIMUM DOOR WEIGHTS OF 100kg EACH

### SIMULTANEOUS ACTION KIT FOR BI-PARTING DOORS

#### APPLICATION

- ▶ Designed to be used in conjunction with a pair of Husky 100 or Pocket Doors Kits (PDK range)
- ▶ For internal partition bi-parting timber doors
- ▶ This kit can be retro fitted to existing installations
- ▶ Ideal for pairs of doors opening into pocket walls
- ▶ For use with either steel or aluminium Husky track
- ▶ Polypropylene coated cable for quiet operation
- ▶ Spring tension providing smooth operation
- ▶ Pulley wheels complete with bearings to provide reliable operation

#### DOOR & GEAR SPECIFICATION

- ▶ Simultaneous Action Kit
- ▶ Minimum Door Weight
- ▶ Maximum Door Weight
- ▶ Maximum Door Thickness
- ▶ Maximum Door Width
- ▶ Door Material

**Husky 100**  
SIM100 x I  
25kg  
100kg  
25-50mm  
1250mm  
Timber

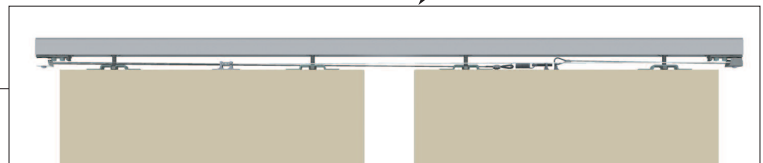
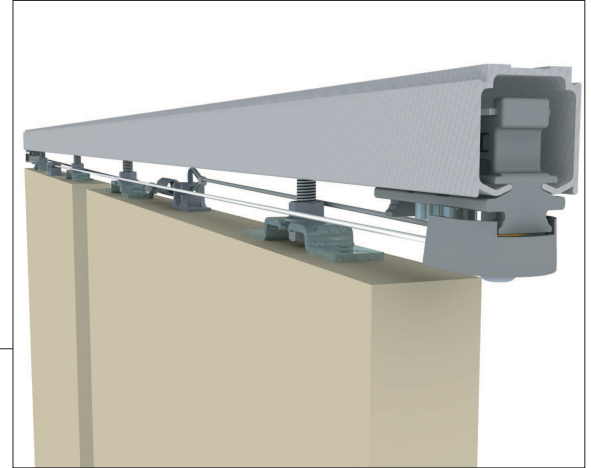

HENDERSON

# SIMULTANEOUS ACTION KIT

**Diagram 1. Left hand clip stop and pulley assembly**

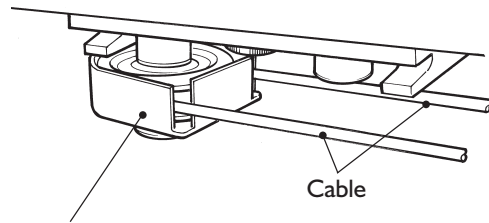

Clip stop end bolt removed and replaced with extended bolt, spacer and pulley assembly

**Diagram 2. Right hand clip stop and pulley assembly**

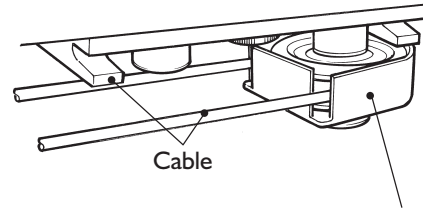

Clip stop end bolt removed and replaced with extended bolt, spacer and pulley assembly

Elevation view of system

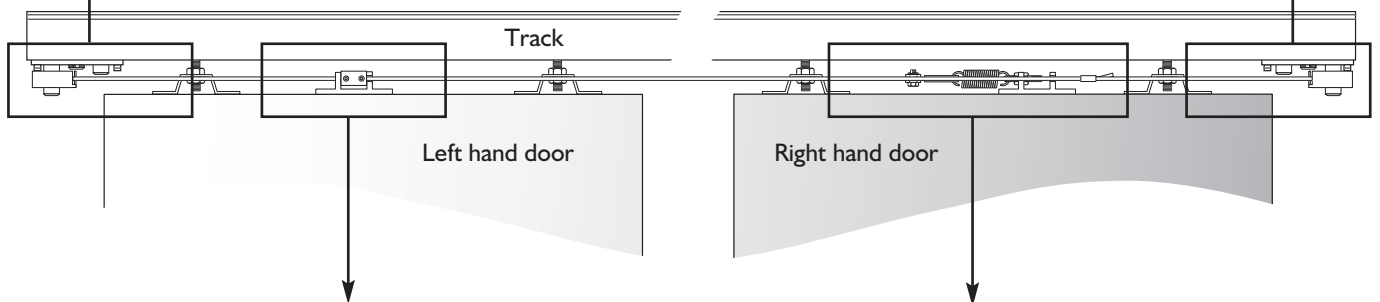

**Diagram 3. Cable anchored to left hand door**

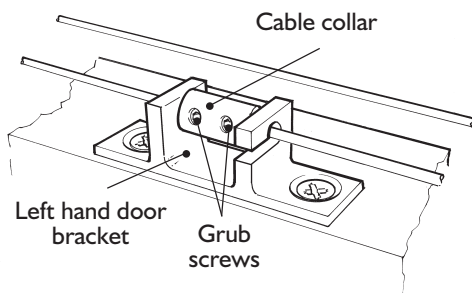

**Diagram 4. Cable anchored to right hand door, tensioning and adjustment bolt.**

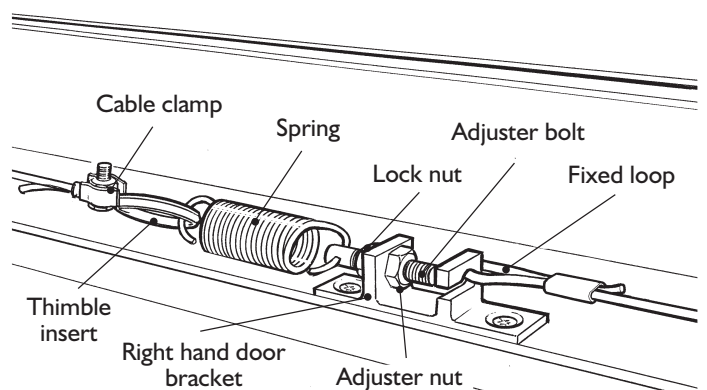

**Diagram 5.**

